

# Instruction Manual

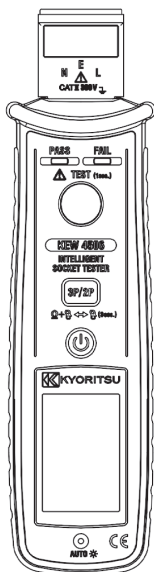

---

**INTELLIGENT SOCKET TESTER**

---

**KEW 4506**



**KYORITSU ELECTRICAL  
INSTRUMENTS WORKS, LTD.**

---

---

## Contents

---

---

KEW 4506

1. Safety precautions .....	1
2. Features .....	5
3. Instrument layout .....	6
4. Accessories .....	9
5. Getting started .....	9
6. Socket test .....	10
6-1 Outlet with earth pole [3P] .....	10
6-1-1 N-E wiring check based on resistances of earth wire (E) and neutral wire (N) .....	11
6-1-2 N-E wiring check based on polarities of voltage signal from signal source (KEW 8343) .....	12
6-1-3 Socket test procedures.....	13
6-1-4 Connection of KEW 8343 .....	15
6-1-5 How to use KEW 4506.....	25
6-2 2P outlet .....	30
7. Settings .....	33
7-1 Disabling resistance measurement of earth wire (E) and neutral wire (N): 3P outlet .....	33
7-2 Buzzer and backlight settings .....	34
8. LCD backlight .....	35
9. Battery replacement .....	36
10. Specifications .....	37

---

---

## 1. Safety precautions

---

---

This tester has been designed, manufactured, and tested according to IEC 61010 (CAT II 300V): Safety requirements for Electronic measuring apparatus, and delivered in the best condition after passing quality control tests.

**This instruction manual contains warnings and safety rules which must be observed by the user to ensure safe operation of the tester and retain it in safe condition. Therefore, read through these operating instructions before starting to use the tester.**

**⚠ DANGER**

- Read through and understand the instructions contained in this manual before starting to use the tester.
- Keep the manual at hand to enable quick reference whenever necessary.
- The tester is to be used only in its intended applications.
- Understand and follow all the safety instructions contained in the manual.
- When using the optional KEW 8343 (Signal source) together with KEW 4506, read the instruction manual for KEW 8343 as well.

It is essential that the above instructions are adhered to.

Failure to follow the instructions may cause injury, instrument damage and/or damage to the equipment under test. Kyoritsu is by no means liable for any damage resulting from the tester in contradiction to these cautionary notes.

The symbol ⚠ indicated on the tester means that the user must refer to the related parts in the manual for safe operation of the tester. It is essential to read the instructions wherever the symbol appears in the manual.

- ⚠ **DANGER** : is reserved for conditions and actions that are likely to cause serious or fatal injury.
- ⚠ **WARNING** : is reserved for conditions and actions that can cause serious or fatal injury.
- ⚠ **CAUTION** : is reserved for conditions and actions that can cause injury or instrument damage.

**- Measurement (over-voltage) category -**

To ensure safe operation of measuring instruments, IEC 61010 establishes safety standards for various electrical environments, categorized as CAT O to CAT IV and called measurement categories.

Higher-numbered categories correspond to electrical environments with greater momentary energy, so a measuring instrument designed for CAT III environments can endure greater momentary energy than one designed for CAT II.

- O (None, Other) : Circuits which are not directly connected to the mains power supply.
- CAT II : Primary electrical circuits of the equipment connected to an AC electrical outlet by a power cord.
- CAT III : Primary electrical circuits of the equipment connected directly to the distribution panel, and feeders from the distribution panel to outlets.
- CAT IV : The circuit from the service drop to the service entrance, and to the power meter and primary overcurrent protection device (distribution panel).

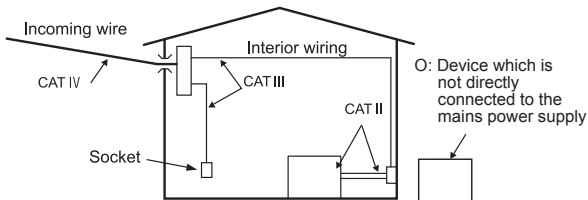

**⚠ DANGER**

- Use the tester under operating conditions as specified; otherwise, the protection supplied by the tester can be compromised and damage itself or lead to a serious accident. Verify proper operation on a well-known source before using the tester, or taking actions against the indication of the tester.
- This tester is rated to CAT II 300 V AC. (max. voltage to ground) Do not test the circuits which exceed this rating: circuits in which 300 V or higher voltage to ground exists.
- Do not attempt to operate this tester in an explosive atmosphere. (e.g.: in the presence of flammable or explosive gasses or vapor)
- Never attempt to use the tester if the tester or your hands are wet.

**- Measurement -**

- Be careful not to short-circuit a power line with the metal tips of KEW 4506 during a measurement. It may cause personal injury.
- Do not exceed the maximum allowable input of any measuring range.
- Never open the battery compartment cover during a measurement.

**⚠ WARNING**





- Always verify the proper operation on a well-known power source before starting to use the tester.
- If any breaks or cracks are noted on the tester or tip plugs, or exposed metal parts are noted, do not use the tester.
- Press the test button after connected to the outlet to be tested.
- Never install substitute parts or make any modifications to the tester. Send the tester to your local KYORITSU distributor for repair or recalibration.
- Do not try to replace batteries if the surface of the tester is wet.
- Firmly insert and attach the conversion adapter to the tip plugs as necessary.
- When opening the battery compartment cover for battery replacement, power off the tester and disconnect from the object to be tested.

### CAUTION

- Do not apply voltage to the tester while the tester is off.
  - Do not attempt to operate the tester in dusty or wet place.
  - Use the tester at a distance as far as possible from a strong magnetic field or energized objects.
  - Never give shocks, such as vibration or drop, which may damage the tester.
- *Battery* -
- Brand and type of the batteries should be harmonized.
- *After use* -
- Always power off the tester after use. Remove batteries if the tester is to be stored and will not be in use for a long period.
  - Do not give vibration, shock, or drop the tester during transportation.
  - Do not expose the tester to the direct sunlight, extremely high temperature and humidity, or dew fall.
  - Use a damp cloth with neutral detergent or water for cleaning the tester. Do not use abrasives or solvents.
  - If the tester is wet, make sure to let it dry before putting it into storage.

The following symbols are marked and used on the tester or in this instruction manual. Before starting to use the tester, please read and understand the meaning of each symbol.

### Symbols

CAT II	Electrical circuits of equipment connected to an AC electrical outlet by a power cord. (Primary side)
	Double or reinforced insulation
	User must refer to the explanations in the instruction manual.
	(Functional) Earth
	This instrument satisfies the marking requirement defined in the WEEE Directive. This symbol indicates separate collection for electrical and electronic equipment.

---

---

## 2. Features

---

---

This is a socket tester which can test wiring connection and find miswiring in:

- \* Single-phase 2-Wire, Single-phase 3-Wire systems,
- \* 3P outlet with earth pole in Three-phase 3-Wire 200 V (delta connection, L2(S) grounded) and Three-phase 4-Wire commercial power line, and
- \* 2P outlet.

For 3P outlet, it is possible to test whether the outlet is correctly wired by using KEW 4506 together with KEW 8343 (signal source). It is applicable to integrated earthing systems with low resistances such as TN, building structure, and common earth systems.

For a wiring system like TT system which has high integrated earth resistance - resistance between N-E exceeds  $2 \Omega$  -, you just need KEW 4506 to perform a test. The tester measures resistance between earth pole (E) and neutral wire (N) and judges N-E connection is correct or reverse. When NE reverse connection is detected, LCD visually shows incorrect wiring. (e.g.: L-N Reverse or E Non-connect, etc.)

- Compatible with 3P and 2P\* outlets
  - \* To connect the tester to 2P outlet, commercially available 3P/2P conversion adapter is required.
- At 3P outlet testing, the tester measures resistance between N-E and displays the value on the LCD. Test current is 10 mA max, therefore, RCDs rated to 30 mA (sensitive current) don't trip unintentionally.
- If N-E resistance measurement function is turned off\*, test is performed with a test voltage applied from an optional signal source only: current flows between N-E is less than  $1 \mu\text{A}$ .
  - \* If the function is disabled, KEW 4506 doesn't show resistance between N-E.
- LCD with backlight. It turns on/ off depending on the ambient brightness.
- Compact and easy-to-use design
- Tester automatically powers off after 10 minutes of no use. This function doesn't work if 80 V or higher voltage is applied to the tester.
- It is possible to disable backlight and buzzer.

### 3. Instrument layout

#### (1) KEW 4506 main unit

Fig. 3-1

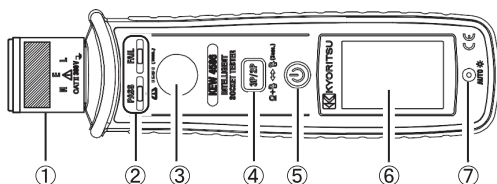

	Name	Description
①	Socket for test lead	Terminal to connect test lead with IEC connector.
②	LED indicator	Indicates test result. Judgement: Correct...Green LED lights up. Reverse.....Red LED lights up.
③	Test button	Test button with touch pad. Hold down 0.5 sec or longer with a bare finger. * Tester measures potential differences between the operator and N terminal by touching the pad at test and check miswiring.
④	3P/2P button	Selects 3P or 2P. ("3P" is always on when powering on KEW 4506.)
⑤	Power button	Powers on/ off KEW 4506 by holding down at least 1 second.
⑥	LCD	With auto-backlight: turns on/ off automatically depending on the ambient brightness.
⑦	Illuminance sensor	Detects ambient brightness and automatically turns on/ off the LCD backlight.



## (2) LCD

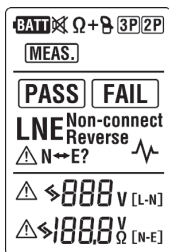





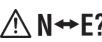



Fig. 3-2

## Displayed segments and symbols

	Testable and selectable socket system: * “” blinks only when testing for the first time with default setting.
	Ready to detect test voltage
	Ready to measure N-E resistance
	Low battery warning
	Buzzer is disabled.
	Appears during judgement is in progress.
	Indicates voltage between L-N.
	Indicates the following values based on the measured N-E voltage. - less than 8.0 V: resistances between 0.0 Ω and 1999 Ω - 8.0 V or higher: voltages between 8.0 V and 20.0 V.

	<p>Indicates the measured values are out of display range.</p> <p>L-N voltage</p> <ul style="list-style-type: none"> <li>&gt; 290V : Measured value is over 290 V.</li> <li>&lt; 80V : Measured value is less than 80 V.</li> </ul> <p>N-E resistance</p> <ul style="list-style-type: none"> <li>&gt; 1999Ω: Measured value is over 1999 Ω.</li> </ul> <p>N-E voltage</p> <ul style="list-style-type: none"> <li>&gt; 20.0V: Measured value is over 20.0 V.</li> </ul>
	<p>Indicates N-E resistance measurement is disabled.</p> <p>* Displayed only when the test voltage is used for wiring check.</p>
	<p>Indicates the result is judged by test voltage detection method.</p>
	<p>Indicates correct wiring.</p>
	<p>Indicates miswiring.</p>
	<p>Indicates N-E connection is unjudgeable.</p>
<p><b>Reverse</b></p>	<p>Indicates wiring errors are detected.</p>
	<p>Indicates abnormal voltage across terminals.</p>
<p><b>Non-connect</b></p>	<p>Indicates incomplete connection.</p>
<p><b>LNE</b></p>	<p>Indicates miswiring or reverse connection terminal.</p>

---

---

## 4. Accessories

---

---

- Carrying case MODEL 9161
- Others:
  - (1) KAMP10 (1500 mm) test lead with IEC connector/  
MODEL 7284 (720 mm) test lead with IEC connector
  - (2) Strap belt
  - (3) Two size AA Alkaline batteries
  - (4) Instruction manual
- Optional accessory  
Signal source KEW 8343 (Diameter 24 mm)

---

---

## 5. Getting started

---

---

Before starting to use KEW 4506, check the following points.

See “9. *Battery replacement*” in this manual and insert batteries.

- (1) Hold down power button 1 sec. to power on KEW 4506.  
A long press (1 sec. or longer) is required to power on the tester for safety purpose. A long press of power button is also required to power off the tester.
- (2) Confirm that battery level indicator **BATT** isn't displayed at the upper left on the LCD.

### Note

- Use of size AA Alkaline battery is recommended. The battery level indicator **BATT** may not be properly displayed if the other types of batteries are used.

Battery level is extremely low when the battery indicator **BATT** is displayed on the LCD. To perform further measurements, please refer to “9. *Battery replacement*” and replace batteries with new ones.

---

---

## 6. Socket test

---

---

This tester is designed to perform wiring check for electrical outlet sockets: 2P and 3P.

**⚠ DANGER**

- This tester is rated to CAT II 300 V AC (max. voltage to ground). Do not test the circuits which exceed this rating: circuits in which 300 V or higher voltage to ground exists.

**Note**

- When conducting a test, stand on the floor and do not touch anything other than the tester to measure electrical potentials precisely when touching the touch pad on the tester.
- The tester may suddenly power off if you continue testing with battery level warning indicator **BATT** is displayed on the LCD.

---

### 6-1 Outlet with earth pole [3P]

---

**Note**

- The tester may show “E Non-connect”, although the outlet is correctly wired, if the earth resistance of the circuit under test is high or voltage between L-E is extremely low due to large leakage currents.

The tester measures the following values and judges whether wall outlets are properly wired or not.

- (1) Voltages across terminals
- (2) Potential differences between N terminal and touch pad (operator)
- (3) Resistances of earth wire (E) and neutral wire (N)
- (4) Polarity of test voltage signal from signal source (KEW 8343)

As for (3) and (4) mentioned above, detailed explanations are described in the following pages.

### 6-1-1 N-E wiring check based on resistances of earth wire (E) and neutral wire (N)

RE ( $RE1 + RE2$ ) in Fig. 6-1 includes earth resistance; therefore, the resistance value is higher than the RN (resistance of a neutral wire). Compare the measured RE and RN and KEW 4506 judges as follows.  $RE > RN$ .....[PASS],  $RE < RN$ .....[NE Reverse]

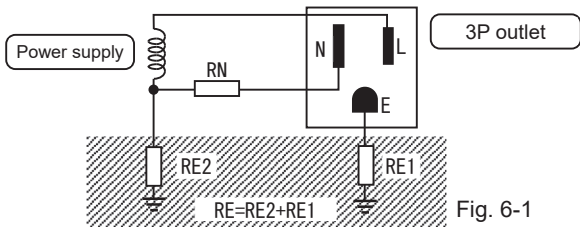

#### Note

This tester cannot be used as an earth resistance tester since the frequency of test current is low: common earth resistance testers may have different resistance measurement values.

If any of the conditions described in the following **CAUTION** or **Note** is applicable, it is recommended to use test voltage signal only with N-E resistance measurement function turning off. See “Outlet with earth pole (3P), resistance of earth wire (E), and turning off resistance measurement of neutral wire (N)” in “7. Settings”.

#### CAUTION

- Anti-trip-technology is applicable to RCDs rated to 30 mA or higher. It's not applicable to RCDs rated to 15 mA.
- RCDs rated to 30 mA or higher may trip if the circuit under test has insulation resistance of 0.1 MΩ or less. It is recommended to measure leakage current before conducting a test and add it to test current of 10 mA max and confirm the total current value doesn't exceed the rated current.
- If insulation monitoring devices are installed, conducting a test may activate the warning alarm. In such case, please contact management company or owner of the test site.

### Note

- When testing 3P outlet, do not connect multiple KEW 4506 at the same time. If testing outlets wired from the same transformer simultaneously, correct judgement result may not be obtained.
- On the following wiring systems, resistance value isn't used for judgment.
  - voltage between N-E is 8 V or more
  - small differences in RN and RE ( $|RN - RE| \leq 1 \Omega$ )
  - low resistance between N-E ( $RN + RE \leq 2 \Omega$ )
  - N-E resistance: over-range ( $RN + RE > 1999 \Omega$ )

### 6-1-2 N-E wiring check based on polarities of voltage signal from signal source (KEW 8343)

As shown in Fig. 6-2, apply test voltage to a neutral wire (N) via signal source. Connect KEW 4506 to a 3P outlet and measure the test voltage between N-E and then compare the phase of test voltage and reference value to judge whether: the phase is the same with the reference value [Correct] or 180-degree reverse (opposite to the reference value) [NE Reverse].

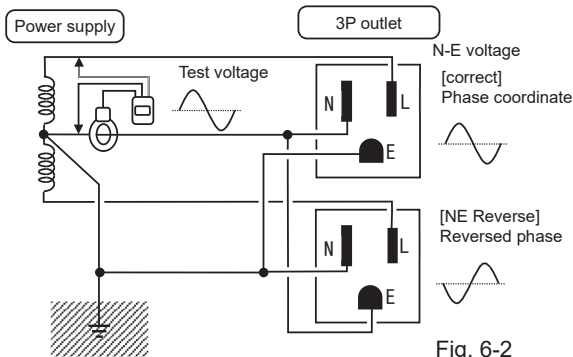

Fig. 6-2

When testing wiring systems such as TT system, which has high total earth resistance (resistance between N-E is 2  $\Omega$  or higher), you just need KEW 4506 and measure resistances of earth pole (E) and neutral wire (N) to check N and E are wired properly.

To test wiring systems with low resistances such as TN, building structure, and common earth systems, connect KEW 8343 to the location close to the branch circuit breaker to which 3P outlet under test is wired and apply test voltage. See “5. *Wiring system*” described in the instruction manual for KEW 8343.

---

### 6-1-3 Socket test procedures

---

KEW 4506 conducts test in the following procedures.

$V_{L-N}$	: Voltage between L-N
$V_{L-E}$	: Voltage between L-E
$V_{N-E}$	: Voltage between N-E
$V_{MAX}$	: The maximum voltage among L-N, L-E, and N-E
●	: Measured voltage is 70% or higher than $V_{MAX}$ .
*	: Measured voltage is less than 70% of $V_{MAX}$ .
RE	: Resistance of earth pole (E)
RN	: Resistance of neutral wire (N)
RNE	: Resistance between neutral wire (N) and earth pole (E)

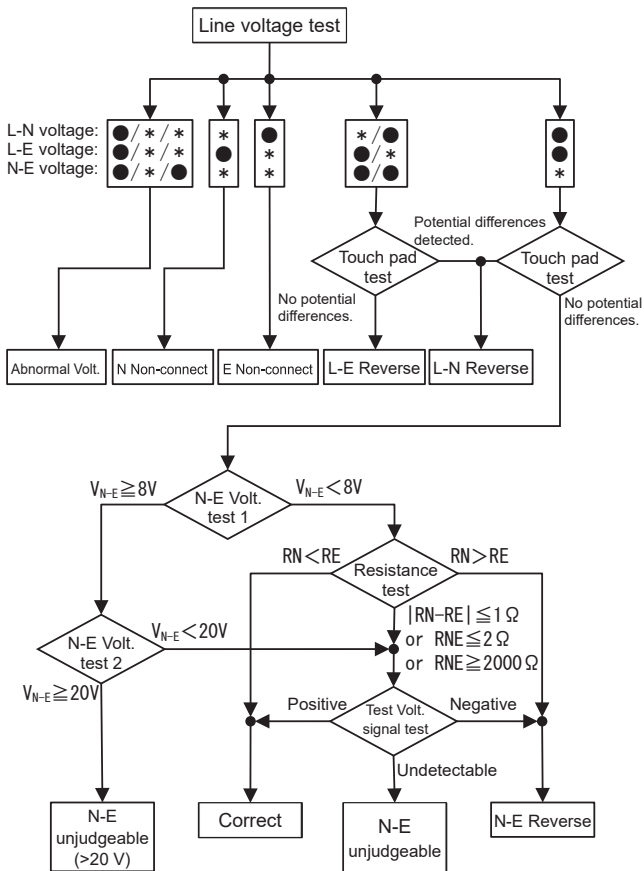

Fig. 6-3



---

## 6-1-4 Connection of KEW 8343

---

### ⚠ To obtain accurate result:

Clamp a neutral wire (N) with test voltage injection clamp observing the orientation shown below: arrow mark on the clamp shall be towards the outlet. Ensure that the transformer jaws are firmly engaged and closed.

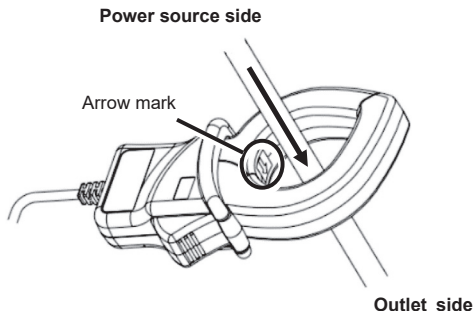

Fig. 6-4

### Note

- To apply test voltage correctly, check the size of conductor to be tested - the maximum measurable conductor size is approx. 24 mm - so that the jaws close completely.

### Note

- As shown in Fig. 6-5, the phase of test voltage applied to a neutral wire (N) changes 180-degree depending on the orientation of the test voltage injection clamp. KEW 4506 performs socket test based on the polarity (phase difference) of the test voltage signal; therefore, if the orientation of test voltage injection clamp is incorrect, KEW 4506 judges as [NE Reverse] even if the tested socket is correctly wired.

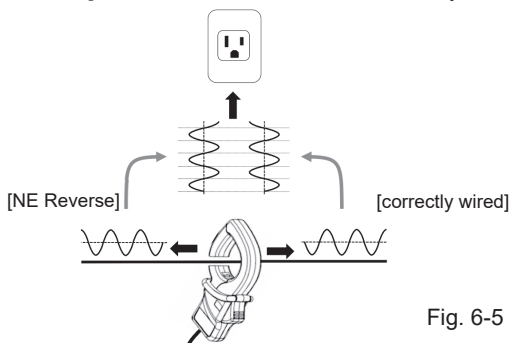

Fig. 6-5

- It is impossible to test ungrounding system (floating power supply) which is mainly utilized in hospital, sound room, and UPS (Uninterruptible Power Supply) because test voltage cannot be applied to.

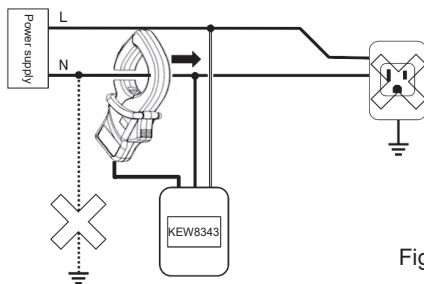

Fig. 6-6

### Note

- Socket test cannot be performed if a neutral wire (N) connected to ground is closer to the outlet to be tested than the clamp position of test voltage injection clamp.

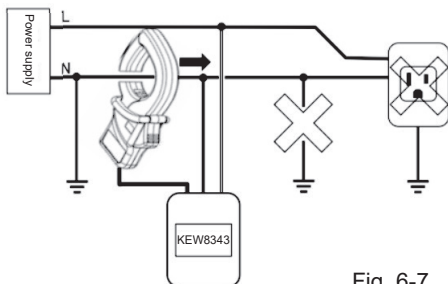

Fig. 6-7

- KEW 8343 and KEW 4506 (Socket tester) cannot perform socket test if they are connected to:

\* a live phase and in which one voltage phase is different from other phases in Three-phase 4-wire system (wye or delta connection).

That is, if you make connections as illustrated on the next page (Fig. 6-9 and Fig. 6-10) for the wiring systems described below, correct measurement result cannot be obtained.

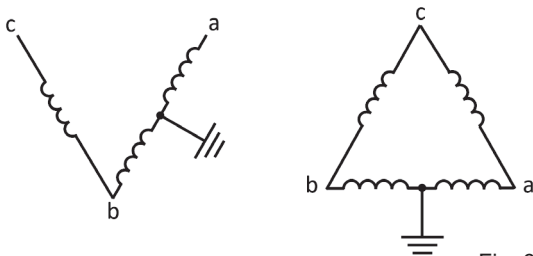

Fig. 6-8

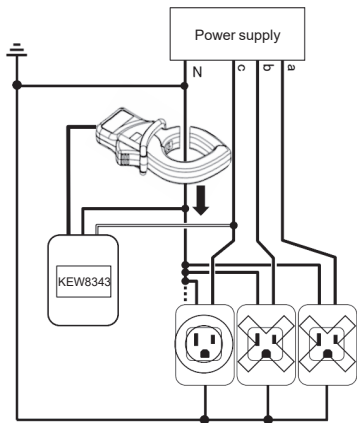

Fig. 6-9

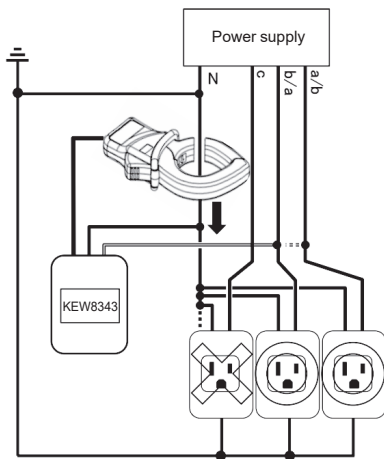

Fig. 6-10

### Single-phase 2-Wire

Clamp the neutral wire (N) with test voltage injection clamp and black voltage detection cable to neutral wire (N) and red voltage detection cable to hot/live wire (L).

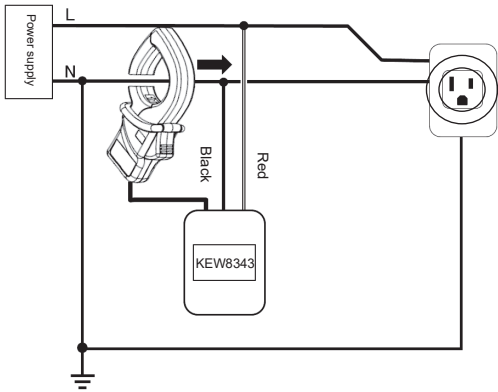

Fig. 6-11

### Single-phase 3-Wire

Clamp the neutral wire (N) with test voltage injection clamp and black voltage detection cable to neutral wire (N) and red voltage detection cable to hot/live wire: either L1 or L2 correctly. Then you can test any 3P sockets which are connected to L1 or L2.

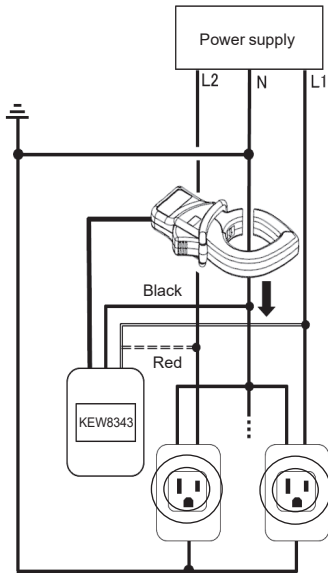

Fig. 6-12

### Three-phase 3-Wire 200 V (delta connection, L2(S) grounded)

Clamp the grounded L2(S) with the test voltage injection clamp and connect the black voltage detection cable to L2(S) and red voltage detection cable to a hot/live wire: either L1(R) or L3(T) correctly. Then you can test any 3P outlets which are connected to L1(R) or L3(T).

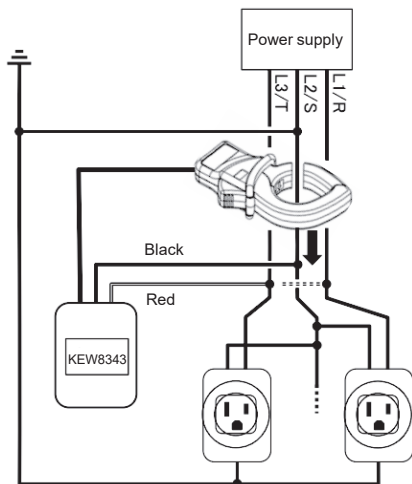

Fig. 6-13

### Three-phase 4-Wire

Clamp the neutral wire (N) with test voltage injection clamp and black voltage detection cable to neutral wire (N) and red voltage detection cable to hot/live wire: either L1(R), L2(S), or L3(T) correctly. Then you can test any 3P outlets which are connected to L1(R), L2(S), or L3(T).

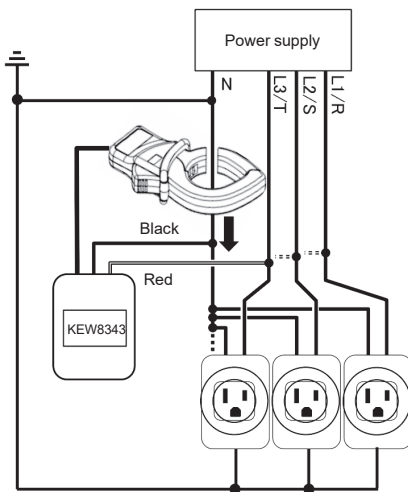

Fig. 6-14



### Note

- Check the wiring diagram before making connections and identify the branch circuit breaker to which 3P outlet is wired, and then connect the injection clamp close to the outlet to be tested.

Depending on the orientation of the test voltage injection clamp, as explained with Fig. 6-5 at the previous clause, KEW 4506 may judge as [NE Reverse] even if the outlet is correctly wired as shown in Fig. 6-15 (outlet wired to branch circuit breaker [B]). Connect the test voltage injection clamp to the appropriate neutral wire (N) of the branch circuit breaker with the correct orientation and location.

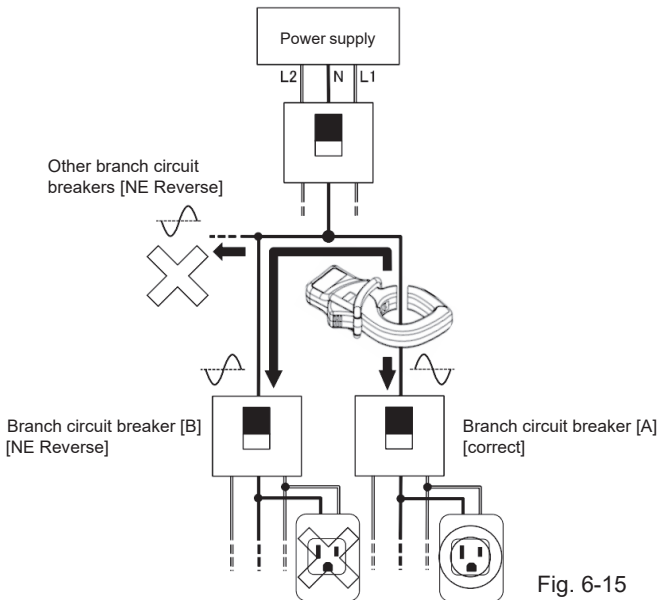

Fig. 6-15

### Note

- When the test voltage injection clamp is connected close to the distribution board, KEW 4506 can test the outlet which is wired to branch circuit breaker [B] shown in Fig. 6-15 and judge as “PASS” (correct); however, it is NOT recommended to connect test voltage injection clamp to the position shown in Fig. 6-16. This is because KEW 4506 may show “ $\Delta N \leftrightarrow E?$ ” if multiple loads are connected to an outlet wired from any of the other branch circuit breakers, which is not the one to be tested, and where those loads are active.

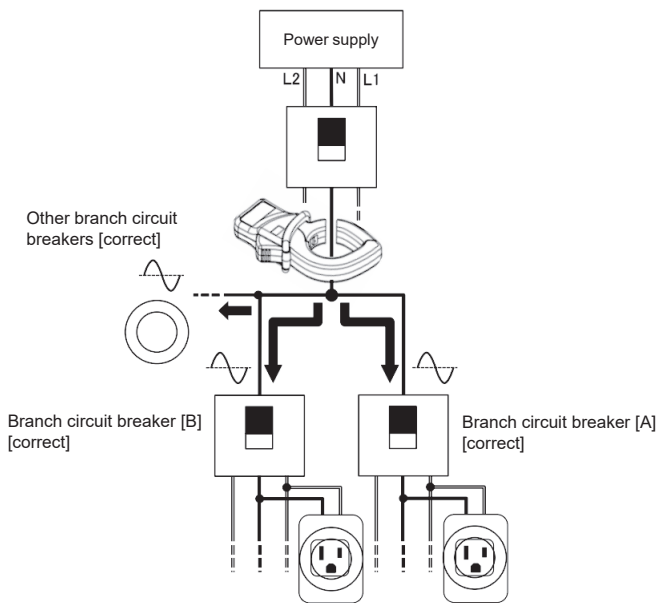

Fig. 6-16

## 6-1-5 How to use KEW 4506

(1) Press **3P/2P** button to select “3P”.

When you test a 3P socket with earth pole (E) correctly connected, while “2P” has been selected with **3P/2P** button, KEW 4506 automatically switches the settings for “3P” and **3P** indicator blinks at testing for the first time.

(2) Connection

### ⚠ CAUTION

- Use the power cord and test leads supplied with the tester only. Kyoritsu is by no means liable for any damage resulting from the use of commercially available power cord and test leads.
- KEW 4506 may not judge the wiring condition if test lead with IEC connector KAMP10 or MODEL 7284 is degraded and the internal resistances are extremely changed.

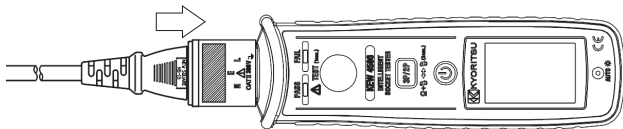

Fig. 6-17

Firmly connect test lead with IEC connector KAMP10 or MODEL 7284 to KEW 4506 before connecting the plug of the test lead to the outlet to be tested.

**⚠ DANGER**

- If earth wire of conversion adapter is connected to the earth terminal of the outlet, wear a pair of insulated gloves or other protective gears, and do not touch the earth terminal of the outlet to avoid electrical shock accident due to wiring error.

**⚠ CAUTION**

- Do not apply excessive force to the tip of outlet plug.

**Note**

- When conducting a test, stand on the floor and do not touch anything other than the tester to measure electrical potentials precisely.



When KEW 4506 detects miswiring, any of the following indications is displayed on the LCD. See Fig. 6-20. In addition, red LED indicator lights up, as Fig. 6-21 shows, with continuous beep sounds.

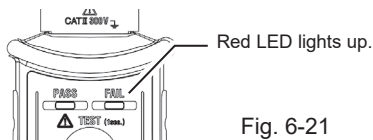
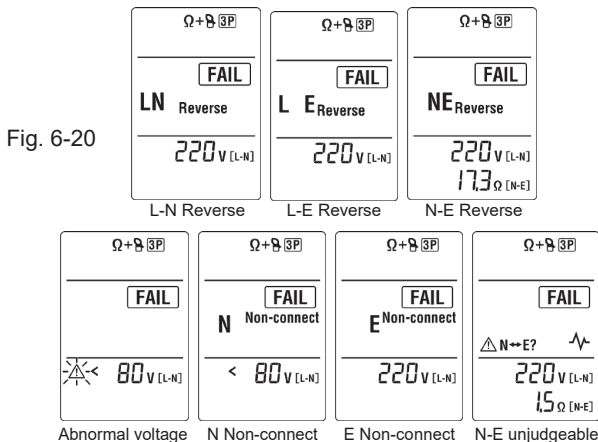

- Measured value displayed on the bottom area of LCD in case of “N-E Reverse”

Resistance value : N-E resistance determined by measuring resistance between neutral wire (N) and earth wire (E) is displayed.

Voltage value : N-E voltage is displayed if voltage between N-E is 8 V or higher. When N-E voltage is higher than 8 V, KEW 4506 cannot measure resistance.

- Measured value displayed on the bottom area of LCD in case of N-E unjudgeable

Resistance value : N-E resistance or “>1999  $\Omega$ ” is displayed when N-E resistance is 2  $\Omega$  or less or exceeds 1999  $\Omega$  and the tester cannot detect test voltage applied via signal source.

Voltage value : N-E voltage or “>20 V” is displayed if N-E voltage is 8 V or higher and the tester cannot detect test voltage applied via signal source. When N-E voltage is 8 V or higher, KEW 4506 cannot measure resistance.

- Possible causes when test voltage from signal source cannot be detected:

Check the signal source (KEW 8343) connected within a branch circuit breaker is NOT in the following status.

Green Power LED is blinking.

Battery voltage is low. Please refer to the manual for signal source and replace batteries with new ones.

Signal source is clamped in incorrect location.



Please refer to each “Note” described in *6-1-4 Connection of KEW 8343* and make connections in correct position observing correct orientation.

Large load current is flowing through the clamped neutral wire (N).

Signal source cannot apply test voltage correctly if large current exceeding 100 A is flowing through a neutral wire (N). In this case, turn off the load of the object to be tested or disconnect the load once and try to apply test voltage again.

Clamp jaws aren't closed completely.

Buzzer keeps beeping if the jaws aren't closed completely. If buzzer keeps beeping even though signal source is clamping a neutral wire (N) and jaws are firmly closed, load current exceeding 30 A may be flowing on the neutral wire. In this case, test voltage is being applied correctly though buzzer keeps beeping.

Measured result remains displayed until test button  or  button is pressed.

- Voltage warning

If voltage of 253 V or higher is applied to any of the three terminals, KEW 4506 gives audible warning with blinking  symbol and “V[L-N]” as shown in Fig. 6-22. Even while the tester is giving voltage warning, the tester can perform tests if voltages are 290 V or less.

The tester doesn't start a test even if the test button  is pressed when 290 V or higher voltage is applied to any of the three terminals.

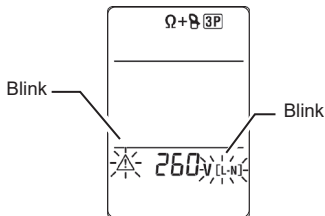

Fig. 6-22

---

## 6-2 2P outlet

---

### (1) Test method

The tester conducts the following two measurements and judges whether wall outlets are properly wired or not.

1) Voltage between L-N terminals

2) Potential differences between N terminal and touch pad (operator)

Judgement result	L-N voltage	Potential differences (between N terminal and touch pad)
PASS	✓	X
FAIL: LN Reverse	✓	✓
FAIL: <80V [L-N]	X	



(2) Press  button to select “2P”.

**Note**

- Settings always restore to the ones for 3P socket whenever powering on the tester.
- If the earth terminal of the outlet to be tested is earthed at 2P test, the settings automatically change to the ones for “3P”.

(3) Connection

 **CAUTION**

- When earth pole (E) is connected, settings automatically change to the ones for “3P”.
- Kyoritsu is by no means liable for any damage or injury resulting from the use of 3P/ 2P conversion adapter.

A 3P/ 2P conversion adapter, which is required to connect with 2P outlet, isn't supplied with the tester. Prepare commercially available 3P/ 2P conversion adapter to connect the tester to 2P outlet, and attach it to the plug part of test lead with IEC connector KAMP10 or MODEL 7284 before conducting a test. Observe the correct orientation and connect to the outlet to be tested.

**Note**

- When conducting a test, stand on the floor and do not touch anything other than the tester to measure electrical potentials precisely.
- If 3P/ 2P conversion adapter you prepared has exposed metal terminals, do not touch the metal terminals during a test. KEW 4506 judges as “N-E Reverse” even if the outlet under test is correctly wired.

#### (4) Measurement

Press the test button  0.5 sec. Press the button with bare hand since it works as touch pad. KEW 4506 starts measurement in 0.5 sec. with audible warning.

The LCD screen will be like Fig. 6-23 when the wiring is correct. In addition, green LED indicator lights up as shown in Fig. 6-24 and beep sounds once.

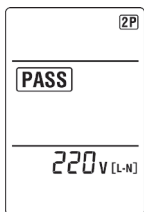
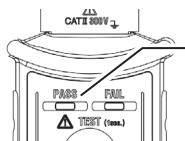

Fig. 6-23



Green LED lights up.

Fig. 6-24

When the tester detects miswiring, the LCD shows either of the following indication as shown in Fig. 6-25 and red LED indicator lights up to indicate miswiring with continuous beep sounds (Fig. 6-26).



L-N Reverse

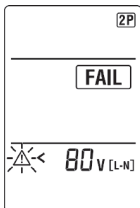

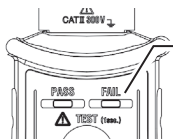

Abnormal voltage

Fig. 6-25



Red LED lights up.

Fig. 6-26

Measured result remains displayed until test button  or  button is pressed.

- Voltage warning

If voltage of 253 V or higher is applied between two terminals, KEW 4506 gives audible warning with blinking  symbol and “V[L-N]” as shown in Fig. 6-27. Even while the tester is giving voltage warning, the tester can perform tests if voltages are less than 290 V.

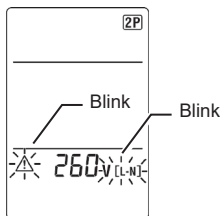



Fig. 6-27

The tester doesn't start a test even if the test button  is pressed when 290 V or higher voltage is applied between two terminals.

## 7. Settings

### 7-1 Disabling resistance measurement of earth wire (E) and neutral wire (N): 3P outlet

Disabling N-E resistance measurement and using test voltage signal only is recommended if the test site is applied to the conditions mentioned in cautions on page 11 and 12 in this manual. Current flows by applying test voltage signal between N-E is less than 1  $\mu$ A.

**Note**

- Use of signal source (KEW 8343) is required to conduct a test when N-E resistance measurement is disabled.
- Settings won't be cleared by powering off KEW 4506.

Holding down  3 sec. switches resistance measurement ON/ OFF.

While resistance measurement is OFF (disabled), “ $\Omega$ +” symbol doesn't appear and resistance value isn't displayed as shown in Fig. 7-1.

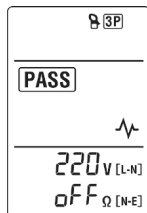

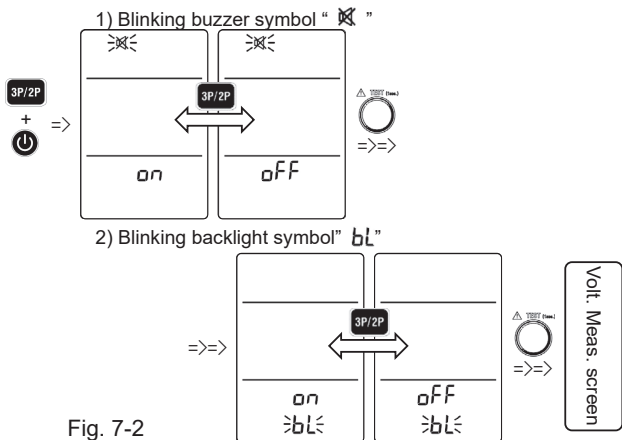

Fig. 7-1

## 7-2 Buzzer and backlight settings

Buzzer and backlight function can be turned ON/ OFF respectively. See Fig. 7-2.

- (1) Power off KEW 4506 if it is on.
- (2) Press  button 1 sec. with holding down **3P/2P** button. Now the tester enters setting mode.
- (3) Press **3P/2P** button and set the displayed function either ON or OFF, and then press  to confirm the selection and move to the next setting item.



### 1) Buzzer OFF

When "OFF" is selected and set, "  " symbol is displayed and buzzer doesn't sound.

## 2) Backlight OFF

When “OFF” is selected and set, LCD backlight doesn’t turn on.

The number of beeps when powering on the tester indicates the currently selected settings.

(No beep sounds when buzzer function is off.)

Number of beeps	Setting
Once	Automatically turns on/ off.
Twice	Backlight is disabled. (Always off.)

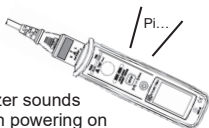

Buzzer sounds when powering on the tester.

Fig. 7-3

---

---

## 8. LCD backlight

---

---

### Note

- Keep the surface of the illuminance sensor clean to ensure proper detection of brightness.
- The sensitivity of the sensor is not adjustable. Cover the sensor with your finger to turn on the light manually.

The illuminance sensor on the tester detects ambient brightness and automatically turns on/ off the LCD backlight. Once the light turns on, it stays on for about 15 seconds in a good light place.

The light turns off automatically after 2 minutes of no use even in a dark place. A light press of power button turns on the LCD backlight again. Ambient brightness is detected by the illuminance sensor shown in Fig. 8-1.

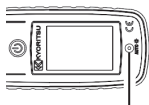

Illuminance sensor

Fig. 8-1

---

---

## 9. Battery replacement

---

---

### **⚠ DANGER**

- Do not try to open the battery compartment cover if the surface of the tester is wet.
- Do not replace batteries during a measurement.
- The battery compartment cover must be closed and screwed before starting a measurement. Otherwise, electrical shock hazard may be caused.

### **⚠ WARNING**

- In order to avoid getting electrical shock, ensure that the tester is powered off and is disconnected from the object to be tested before opening the battery compartment cover for battery replacement.

### **⚠ CAUTION**

- Do not mix new and old batteries or mix different types of batteries.
- Insert batteries in correct polarity as marked inside.
- Remove batteries if the tester is to be stored and will not be in use for a long period.

- (1) Power off the tester.
- (2) Loosen one battery compartment cover-fixing screw and remove the cover.
- (3) Replace two batteries with new ones at the same time. Confirm new batteries are inserted in the correct polarity.  
Use of two size AA alkaline batteries (LR6) is recommended.
- (4) Install the battery compartment cover, and tighten the screw and secure the cover.

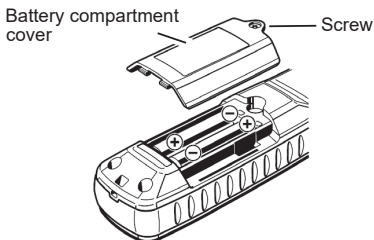

---

---

## 10. Specifications

---

---

- Location for use : In-door use, Altitude up to 2000m  
3P or 2P outlet with earth pole up to 253 V in Single-phase 2-Wire, Single-phase 3-Wire, Three-phase 3-Wire 200 V (delta connection, L2(S) grounded), Three-phase 4-Wire commercial power line
- Temp. & humidity range : 23°C±5°C, relative humidity 85% or less  
(accuracy guaranteed) (no condensation)
- Operating Temp.& humidity range : -10°C to 50°C, relative humidity 85% or less  
humidity range (no condensation)
- Storage Temp. & humidity range : -20°C to 60°C, relative humidity 85% or less  
humidity range (no condensation)
- Withstand voltage : 2210 V AC (50/60 Hz)/ for 5 sec.  
between electrical circuit and enclosure
- Insulation resistance : 50 MΩ or more / 1000 V DC  
between electrical circuit and enclosure
- Applicable standards : IEC 61010-1/ -2-030, CAT II 300V,  
Pollution degree 2, IEC 63000 (RoHS)
- Dustproof/ waterproof : IEC 60529 IP40
- LCD : Segment display with backlight
- Dimension : 212(L) × 56(W) × 39(D) mm
- Weight : Approx. 250g (including batteries)
- Power source : Size AA battery x 2 pcs.  
(Alkaline LR6 is recommended.)
- Possible number of measurements  
When testing 3P outlet once every 30 sec. with AA alkaline batteries:

N-E resistance	Possible number of measurements within effective battery voltage range
10 Ω	Approx. 3000 times

- L-N RMS voltage (in stand-by mode)

Measuring range / Display range	Accuracy
80 Vrms – 290 Vrms (50 Hz/ 60 Hz)	±2%rdg±4dgt <sup>*1</sup>

<sup>\*1</sup> Add ±3dgt to the specified accuracy for the sine waves other than CF<2.5 (411Vpeak).

- Socket test

(1) Measurable range of power supply voltage

The tester gives voltage warning if 253 V or higher voltage is detected but it can perform socket test.

Power supply voltage
80 Vrms – 290 Vrms (50 Hz/ 60 Hz)

\* 290 V or higher voltage: KEW 4506 doesn't start test even though the test button is pressed.

\* Voltages less than 80 V: Judged as abnormal voltage.

(2) Judgement

The LCD shows any of the followings depending on the measured result.

3P	2P
1) PASS 2) L-N Reverse 3) L-E Reverse 4) N-E Reverse 5) E Not connected 6) N Not connected 7)  <b>N↔E?</b> 8) Abnormal voltage	1) PASS 2) L-N Reverse 3) Abnormal voltage

(3) Resistance measurement between N-E

(only when N-E voltage is less than 8 V)

Resistance between N-E is displayed with the judgement result.

Range (Auto-ranging)	Measuring range	Test current	Accuracy
200Ω range	0.0-199.9 Ω	5 mA(5.3 Hz)	±3%rdg±5dgt
2000Ω range	200-1999 Ω	1 mA(5.3 Hz)	

(4) N-E RMS voltage

(displayed only when N-E voltage is 8 V or higher.)

Measuring range
8.0 Vrms – 20.0 Vrms (50 Hz/ 60 Hz)



Memo

Memo



## DISTRIBUTOR

Kyoritsu reserves the rights to change specifications or designs described in this manual without notice and without obligations.



## **KYORITSU ELECTRICAL INSTRUMENTS WORKS, LTD.**

2-5-20, Nakane, Meguro-ku,  
Tokyo, 152-0031 Japan  
Phone: +81-3-3723-0131  
Fax: +81-3-3723-0152  
Factory: Ehime, Japan

**[www.kew-ltd.co.jp](http://www.kew-ltd.co.jp)**